

Technical Bulletin

How to Read ICC Evaluation Service® ESR-1539® Part II: Fastener Basics and Tables 1-3

Preface:

This is the second in a series of technical bulletins designed to provide a clearer understanding of the ICC Evaluation Service® evaluation report ESR-1539®.

This bulletin covers the Table of Contents, the fastener basics, applicable codes and information on the reference lateral design value of nails in some of the common species of wood used in building construction.

The driven fasteners (nails and staples) described in the evaluation report are used in engineered and non-engineered (prescriptive) structural connections and are primarily installed using power tools. This technical bulletin references **ESR-1539® Issue Date 03/2021**.
http://www.icc-es.org/Reports/pdf_files/ESR-1539.pdf

Background:

The first technical bulletin in this series: Terminology Used In ICC Evaluation Service® Report ESR-1539® provides a brief description of several technical and administrative terms used.

The second technical bulletin in this series: Part I: Basic ESR Information covers the first four pages of ESR-1539® and provides information on the document format, subject matter and product descriptions.

Table of Contents & Basic Fastener Styles

A pictorial representation of the various types of nail shanks and heads represented in the ESR along with the basic shape of staples.

Nails have three basic components to them:

- Shank
- Head
- Point

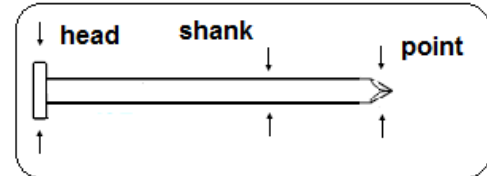

Components of a Nail

Shank and head styles are addressed in ESR-1539® and are referenced below.

Smooth Shank Nails (S): Commonly used in wood framing and the attachment of sheathing e.g., (plywood, OSB, etc.) to wood framing, a smooth shank nail is made of steel and has a shank without deformation.

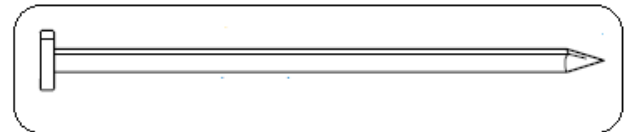

Smooth Shank Nail

Ring Shank Nails (RS): A ring shank nail is comprised of a series of annular rings extending along the shank of the nail. They often vary in the number of rings per inch, depth of the ring and ring pattern based on manufacturer.

Targeted for use in softer woods like pines and firs, ring shank nails are commonly used in roof sheathing application where a higher resistance to removal (withdrawal) from the framing is required. As the nail is driven into the wood, the wood fibers are pushed away from the shank of the nail. After the nails have been driven, the wood fibers begin to relax and fill in the grooves of the rings formed in the nail shank.

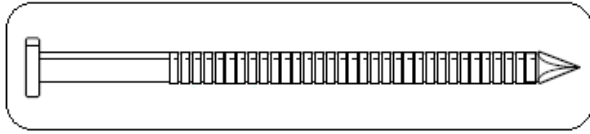

Ring Shank Nail

Screw Shank Nails (Sc): A screw shank nail is made of steel with a helical or screw type twist extending along the shank. Similar to ring shank nails, they can provide higher resistance to withdrawal vs. smooth shank nails. They are often used for harder / denser woods. As the nail is driven, it twists and forms its own thread in the wood fibers. As with the ring shank nail, the depth and spacing of the twist or spiral in the nails differ by manufacturer.

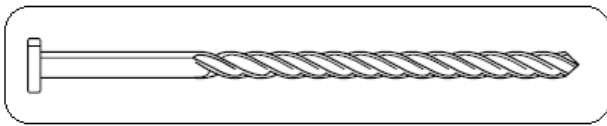

Screw Shank Nail

Full Round Head (FRH): The full round head nail is associated with the nails addressed in section 8.2.3.1 of ASTM F1667 and the common, box or cooler nails prescribed in the codes for use in diaphragms, shear walls and framing. The shank and the head are concentric to each other in a FRH nail. FRH nails can be driven with pneumatic nailers or hand driven with a hammer.



Full Round Head

Notched Head, D-Head & Offset Head: These head shapes allow for a larger number of nails to be closely spaced together when the nails are collated in paper tape, plastic strip or wire for use with power nailers. The collation is often formed at an angle that is compatible with the magazine of the nailer. This allows the point of the nail to be presented to the work surface at a 90° angle. Notched and D-heads are often referred to as “clipped” heads.

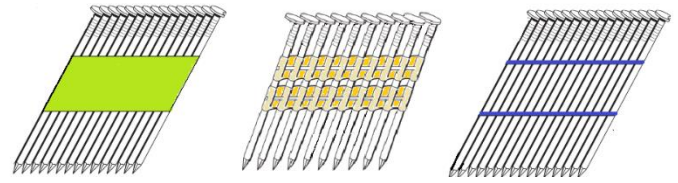

Paper

Plastic

Wire

Angled Collation

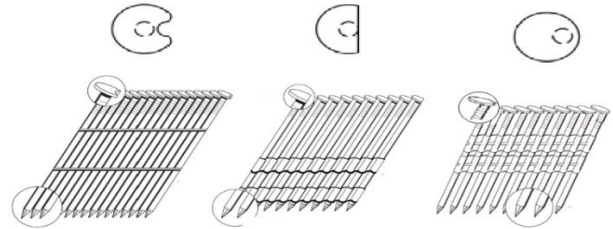

Clipped Head

D-Head

Offset Round Head

Staples: Staples addressed in ESR-1539® are made of plain, galvanized, or stainless steel wire. Galvanized and stainless steel provide varying levels of corrosion resistance. The minimum crown width prescribed in the codes is 7/16 inch (11mm). The minimum leg length of 1½ inch (38mm) listed is based on the most restrictive fastener connection addressed in ESR-1539®.

Unlike nails, which reference shank diameters in inches, staple crown and leg diameters are referenced by the steel wire gage. Gage is a measure of the diameter of the basic wire that makes up the staple. ESR-1539® lists three gage sizes 14, 15, and 16 which are the prescribed sizes referenced in the codes.

Staple Gage	NOMINAL WIRE DIAMETER
14	0.080
15	0.0720
16	0.0625

Staples are collated into strips and held with polymer coatings.

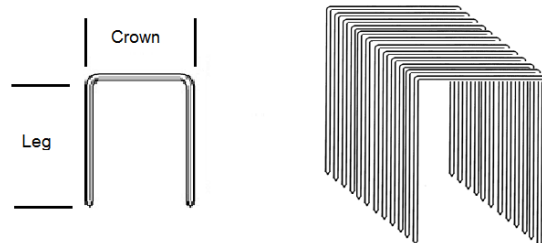

Staples

Listing of Nail Sizes Included in ESR-1539[®]

Table 1* (Figure A) provides information on the types and sizes of nails recognized in ESR-1539[®]. The table is divided into two sections: nails described in ASTM F1667 and “Others” representing alternative nails recognized for specific applications.

The nails described in F1667 tables 5, 10 & 15 are recognized in the International Building Codes (IBC)[®] and International Residential Codes (IRC)[®] for use in the prescriptive connections identified in ESR-1539[®] Tables 4-11.

*Referenced tables are directly related to ESR-1539[®]

TABLE 1—NAIL DIAMETERS ADDRESSED IN THIS REPORT¹

SHANK DIAMETER (inch)	DESCRIBED IN ASTM F1667				OTHERS	
	TYPE AND PENNYWEIGHT	LENGTH (inches)	HEAD DIAMETER (inch)	SHANK STYLE	COMMONLY AVAILABLE LENGTHS (inches)	SHANK STYLES
0.092	6d cooler	1 ⁷ / ₈	0.250	Smooth, Ring, Screw	1 ¹ / ₄ , 1 ¹ / ₂ , 1 ⁵ / ₈ , 1 ³ / ₄ , 2, 2 ¹ / ₈ , 2 ³ / ₁₆ , 2 ¹ / ₄ , 2 ³ / ₈ , 2 ¹ / ₂	Smooth, Ring, Screw
0.099	6d box	2	0.266	Smooth	1 ¹ / ₈ , 1 ¹ / ₂ , 1 ³ / ₄ , 1 ⁷ / ₈ , 2, 2 ¹ / ₄ , 2 ³ / ₈	Smooth, Ring, Screw
0.113	6d common	2	0.266	Smooth	2, 2 ¹ / ₄ , 2 ³ / ₈ , 2 ¹ / ₂	Smooth, Ring, Screw
	8d box	2 ¹ / ₂	0.297			
	8d cooler	2 ³ / ₈	0.281			
0.120	–	–	–	–	2, 2 ¹ / ₄ , 2 ³ / ₈ , 2 ¹ / ₂ , 2 ³ / ₄ , 3, 3 ¹ / ₄ , 3 ¹ / ₂ , 3 ³ / ₄ , 4	Smooth, Ring, Screw
0.131	8d common	2 ¹ / ₂	0.281	Smooth	2, 2 ¹ / ₄ , 2 ³ / ₈ , 2 ¹ / ₂ , 2 ³ / ₄ , 3, 3 ¹ / ₄ , 3 ³ / ₈ , 3 ¹ / ₂ , 3 ³ / ₄ , 4	Smooth, Ring, Screw
	Metal Hardware ²	1 ¹ / ₄ , 1 ¹ / ₂ , 2 ¹ / ₄ , 2 ³ / ₈ , 2 ¹ / ₂	0.281	Smooth, Ring		
0.135	16d box	3 ¹ / ₂	0.344	Smooth	2 ³ / ₈ , 2 ¹ / ₂ , 3 ¹ / ₂	Ring, Screw
0.148	10d common	3	0.312	Smooth	2, 2 ¹ / ₈ , 2 ¹ / ₄ , 2 ³ / ₈ , 2 ¹ / ₂ , 3, 3 ¹ / ₄ , 3 ¹ / ₂ , 4	Smooth, Ring, Screw
	12d common	3 ¹ / ₄	0.312			
	Metal Hardware ²	1 ¹ / ₄ , 1 ¹ / ₂ , 2 ¹ / ₂ , 3, 3 ¹ / ₂	0.281	Smooth, Ring		
0.162	16d common	3 ¹ / ₂	0.344	Smooth	3, 3 ¹ / ₄ , 3 ¹ / ₂ , 4	Smooth, Ring, Screw
	Metal Hardware ²	2 ¹ / ₂ , 3, 3 ¹ / ₂	0.281	Smooth, Ring		
0.180	–	–	–	–	5 ³ / ₈	Smooth
0.197	–	–	–	–	5 ³ / ₈	Smooth

For SI: 1 inch = 25.4 mm.

¹See Appendix B for evaluated nail products for each listee.

²Nails intended for use with metal hardware such as joist hangers. See Appendix B of this report for associated designations on product labels.

designations on product labels.

associated

Figure A – Table 1 from ESR-1539[®]

Note the terminology used to describe the nails referenced in ASTM F1667. Nails used in framing and sheathing are often referred to as common, box or

cooler nails. Tables in F1667 have been specifically defined for each nail type.



- Common nails are everyday nails for use in typical construction
 - They are often addressed with terminology such as 6d common, 8d common, etc.
- Box nails look like common nails but have smaller diameter shanks. In some cases, the head may be larger than a common nail for an equivalent shank diameter
 - They are often addressed with terminology such as: 6d box, 8d box, etc.
- Cooler nails have shank diameters, lengths, and head diameters smaller than box nails
 - They are often addressed with terminology such as 6d cooler, 8d cooler, etc.

Note:

6d common nails ≠ 6d box nails ≠ 6d cooler nails

(This rule applies to the other size nails as well.)

Alternative nails can differ from nails specifically referenced in ASTM F1667 by:

- Shank configuration (e.g., ring or screw shanks)
- Nominal shank diameter
- Length
- Head configuration (e.g., clipped or offset round heads)
- Proprietary coatings applied for corrosion protection or to assist in driving the nail.

Attachment of Sheathing to Framing

Figure B (Table 2 in ESR-1539® next page) provides a method to quickly look up the correct table in the codes to review the prescriptive fasteners for attaching sheathing to framing.

TABLE 2—APPLICABLE FASTENING SCHEDULES IN THE CODES FOR ATTACHMENT OF SHEATHING TO FRAMING

CONSTRUCTION	CODE	TABLE NUMBER
Roof Sheathing Attachment	2021 IBC	2304.10.2
	2018 and 2015 IBC	2304.10.1
	2012 IBC	2304.9.1
	2021, 2018, 2015 and 2012 IRC	R602.3(1), R602.3(2)
Wall Sheathing Attachment	2021 IBC	2304.10.2
	2018 and 2015 IBC	2304.10.1
	2012 IBC	2304.9.1
	2021, 2018, 2015 and 2012 IRC	R602.3(1), R602.3(2), R602.3(3)
Floor Sheathing Attachment	2021 IBC	2304.10.2
	2018 and 2015 IBC	2304.10.1
	2012 IBC	2304.9.1
	2021, 2018, 2015 and 2012 IRC	R602.3(1), R602.3(2)

Figure B- Table 2 from ESR-1539®

Lateral Design Values

Figure C (Table 3 in ESR-1539[®]) provides information on the Reference Lateral Design Values (Z) for four common wood species typically used in construction.

The (Z) values listed are dependent on several factors:

- Nail length
- Nail diameter
- Nail penetration depth into main member

- Side member thickness
- Specific Gravity of the wood members being nailed together.

Figure C assumes that both the main and side members are of the same wood species and are both '2-by' members (e.g., 2x4, 2x6, etc.) which have a nominal minimal thickness of 1½ inch (38mm).

TABLE 3—REFERENCE LATERAL DESIGN VALUES OF FACE NAILED SINGLE SHEAR CONNECTIONS OF “2-BY” MEMBERS TO OTHER MEMBERS OF SAME SPECIES^{1,2,3,4,5,6,7}

NAIL DIMENSIONS		REFERENCE LATERAL DESIGN VALUES FOR SPECIFIC GRAVITIES OF: (lbf)			
Length (inches)	Nail Shank Diameter (inches)	0.42 (e.g., Spruce-pine-fir)	0.43 (e.g., Hem-fir)	0.50 (e.g., Douglas Fir-larch)	0.55 (e.g., Southern Pine)
3½	0.162	111	113	131	143
3¼	0.148	100	102	118	128
3	0.148	100	102	118	128
3½	0.135	88	89	103	113
3¼	0.131	82	84	97	106
3	0.131	82	84	97	106
2½	0.131	63	64	74	81
3¼	0.120	69	71	81	89
3	0.120	69	71	81	89
2½	0.113	54	56	64	70
2¾	0.113	47	49	56	61
2¼	0.099	36	36	42	46

For **SI**: 1 inch = 25.4 mm, 1 lbf = 4.45N, 1 psi = 6.89 kPa.

¹Design values are based on a normal load duration.

²Table values must be multiplied by all applicable adjustment factors in the NDS.

³Table is based upon a 1½-inch actual thickness of both attached member and receiving ("main") member.

⁴Design values are for connections in which the nail shank is driven into the side grain with shank axis perpendicular to wood fibers. Tabulated values are based on a minimum fastener bending yield strength (F_{yb}) of 100,000 psi for nail diameters of 0.135 inch or less, and a minimum fastener bending yield strength (F_{yb}) of 90,000 psi for nail diameters of 0.148 and 0.162 inch.

⁵Calculations are based on a connection in which both members have the same specific gravity.

⁶Reference lateral design values apply to nails with either a smooth shank or a deformed shank.

⁷Tabulated conditions achieve the minimum penetration depth of 6D required by Section 12.1.6.4 of the NDS (Section 12.1.6.5 of the NDS for the 2015 IBC, Section 11.1.6.5 of the NDS for the 2012 IBC), but may have penetration depth less than 10D. Tabulated values are based on the expected penetration depths for the tabulated conditions.

Figure C - Table 3 from ESR-1539[®]

Additional Note: Footnotes to NDS Tables 12N-12R state that a nail must penetrate a minimum length of 6 times the diameter of the nail (6D) into the main member, but if penetration is less than 10 times the

diameter (10D) a reduction in the lateral design value (Z) must be taken. The reduction calculation is provided in the footnotes of the NDS tables.

Example: (Figures D & E)

Given:

Nail Diameter = 0.131 inch

Nail lengths: 2½, 3, 3¼ inch

6D penetration = 6 x 0.131 = 0.786 inch

10D penetration = 10 x 0.131 = 1.31 inch

- a. 2½ inch nail penetrates into main member 1 inch
- b. 3 inch nail penetrates into main member 1½ inch
- c. 3¼ inch nail penetrates 1½ inch and extends through the main member.

a. The 2½ inch nail penetrates greater than 6D into the main member, but less than 10D. The (Z) value is reduced per NDS requirements.

b. The 3 inch nail penetrates greater than 10D into the main member, so there is no reduction in the (Z) value.

c. The 3¼ inch nail has greater than 10D penetration into the main member, so there is no reduction in the (Z) value even though the nail extends through the main member.

Analysis:

TABLE 3—REFERENCE LATERAL DESIGN VALUES OF FACE NAILED SINGLE SHEAR CONNECTIONS OF “2-BY” MEMBERS TO OTHER MEMBERS OF SAME SPECIES^{1,2,3,4,5,6,7}

NAIL DIMENSIONS		REFERENCE LATERAL DESIGN VALUES FOR SPECIFIC GRAVITIES OF: (lbf)			
Length (inches)	Nail Shank Diameter (inches)	0.42 (e.g., Spruce-pine-fir)	0.43 (e.g., Hem-fir)	0.50 (e.g., Douglas Fir-larch)	0.55 (e.g., Southern Pine)
3½	0.162	111	113	131	143
3¼	0.148	100	102	118	128
3	0.148	100	102	118	128
3½	0.135	88	89	103	113
3¼	0.131	82	84	97	106
3	0.131	82	84	97	106
2½	0.131	63	64	74	81
3¼	0.120	69	71	81	89
3	0.120	69	71	81	89
2½	0.113	54	56	64	70
2¾	0.113	47	49	56	61
2¼	0.099	36	36	42	46

For **SI**: 1 inch = 25.4 mm, 1 lbf = 4.45N, 1 psi = 6.89 kPa.

¹Design values are based on a normal load duration.

²Table values must be multiplied by all applicable adjustment factors in the NDS.

³Table is based upon a 1½-inch actual thickness of both attached member and receiving (“main”) member.

⁴Design values are for connections in which the nail shank is driven into the side grain with shank axis perpendicular to wood fibers. Tabulated values are based on a minimum fastener bending yield strength (F_{yb}) of 100,000 psi for nail diameters of 0.135 inch or less, and a minimum fastener bending yield strength (F_{yb}) of 90,000 psi for nail diameters of 0.148 and 0.162 inch.

⁵Calculations are based on a connection in which both members have the same specific gravity.

⁶Reference lateral design values apply to nails with either a smooth shank or a deformed shank.

⁷Values shown reflect the mandatory NDS reduction required for nails not meeting the minimum 10d nail penetration into the main member.

Figure D - Table 3 from ESR-1539[®]
Emphasis and annotation added for clarity of design example



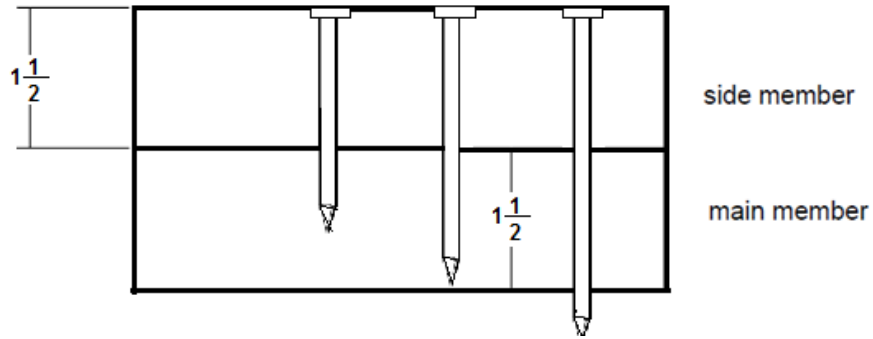

Figure E

Equations for calculating the Z value are referenced in Appendix A of ESR-1539[®]

In 2017 ASTM F1667 was updated to include a class of nails referred to as Metal Hardware Nails (MHN). These particular nails are used in framing applications for the attachment of metal side plates and engineered metal connectors.

Although not new to the industry, Appendix B of the report was updated to include MHN nails for those members who provide them to the market. With the updates to Appendix B, a new table, Table 4 Reference

Lateral Design Values for Face Nailed Single Shear Connections of Steel Side Members to Wood Member was added to the report. (see Figure G)

Table 4 is based on The engineering equations for calculating metal to wood lateral design values are the same as those used in wood to wood and are referenced in Appendix A of ESR-1539[®]

Metal hardware manufacturers and the NDS reference gage thickness for the steel side members. The range of typical steel thicknesses for hardware manufacturers and the NDS are referenced in Table 3B

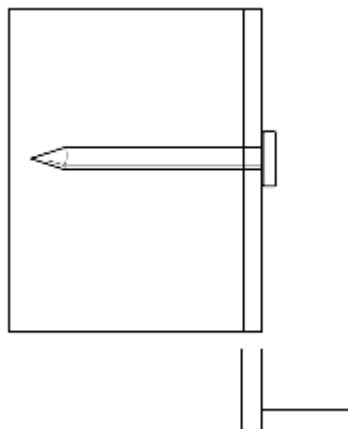

Referenced steel thickness varies between information published by hardware manufactures and the NDS

Figure F

Table 4-REFERENCE LATERAL DESIGN VALUES FOR FACE NAILED SINGLE SHEAR CONNECTIONS OF STEEL SIDE MEMBERS TO WOOD MEMBERS^{1,2,3,4}

Steel Side Member Thickness ⁶ (inch)	REFERENCE LATERAL DESIGN VALUES FOR SPECIFIC GRAVITIES ⁵ OF: (lbf)														
	Spruce-Pine-Fir (0.42)					Douglas Fir-Larch (0.50)					Southern Pine (0.55)				
	Nail Diameter (inch)					Nail Diameter (inch)					Nail Diameter (inch)				
	0.131		0.148		0.162	0.131		0.148		0.162	0.131		0.148		0.162
	Nail Length (inches)					Nail Length (inches)					Nail Length (inches)				
	1½	2¼, 2¾	1½	2½	3	2½, 3, 3½	1½	2¼, 2¾	1½	2½	3	2½, 3, 3½	1½	2¼, 2¾	1½
ASTM A653, Grade 33 Steel Side Plate															
0.033-0.036	82	82	97	97	117	94	94	112	113	136	102	102	122	123	147
0.044-0.048	83	83	97	98	117	95	95	112	114	136	102	102	122	124	148
0.055-0.060	84	84	97	99	118	96	96	113	115	138	104	104	122	125	149
0.0685 - 0.075	86	86	98	102	121	98	98	114	118	140	106	106	123	127	151
0.0975 - 0.105	93	93	103	108	127	105	105	118	125	147	113	113	128	135	159
0.1275 - 0.134	102	102	109	118	137	115	115	126	135	157	124	124	135	146	170
0.1715 - 0.179	116	116	123	137	157	132	132	138	154	177	142	142	149	166	190
0.2285 - 0.24	111	116	119	140	168	127	132	137	160	192	138	144	148	174	209
ASTM A653, Grade 40 Steel Side Plate															
0.033 - 0.036	83	83	97	98	117	95	95	113	114	137	103	103	123	124	149
0.044 - 0.048	84	84	98	99	118	96	96	114	116	138	104	104	123	125	150
0.055 - 0.060	86	86	99	101	120	98	98	115	117	141	106	106	124	127	151
0.0685 - 0.075	89	89	101	104	123	101	101	117	121	144	109	109	126	130	155
0.0975 - 0.105	97	97	107	113	132	110	110	123	130	155	118	118	133	140	164
0.1275 - 0.134	108	108	115	124	143	122	122	133	143	168	131	131	143	154	178
0.1715 - 0.179	116	116	127	141	167	133	133	145	161	193	145	145	157	175	203
0.2285 - 0.24	112	116	120	141	169	128	133	137	161	193	139	145	149	175	210
ASTM A36, Steel Side Plate															
(0.250)	111	117	117	139	169	128	134	137	162	194	139	145	157	186	222

For SI: 1 inch = 25.4 mm, 1 lbf=4.45N, 1 psi=6.89kPa.

¹Design values are for normal loads and must be multiplied by all applicable adjustment factor in the NDS

²The tabulated values have been calculated in accordance with the Yield Mode Equations in Appendix A1.2. Dowel bearing strengths (F_{es}) used to calculate design values are 61,850 psi for ASTM A653, Grade 33; 75,600 psi for ASTM A653 Grade 40; and 87,000 psi for ASTM A36 side member material.

³Lateral design values are based on $F_{yb} = 100,000$ psi for 0.131 inch-diameter nails; and $F_{yb} = 90,000$ psi for 0.148 and 0.162 inch diameter nails

⁴Wood member must be of sufficient thickness for the nail to be fully embedded in the wood.

⁵Specific Gravity values must be the assigned specific gravity from Table A or NDS Table 12.3.3A (2012 NDS Table 11.3.3A for the 2012 IBC) or the equivalent specific gravity for engineered wood products, as shown in an ICC-ES evaluation report.

⁶These thicknesses are based on typical steel thicknesses recognized in various ICC-ES evaluation reports for metal hardware and on the thicknesses addressed in Table 12P of the 2018 and 2015 NDS.

Figure G – Table 4 taken from ESR-1539®

Referenced Documents:

ANSI/AWC NDS-2018 National Design Specification for Wood © American Wood Council 2017

ANSW/AWC 2021 Special Design Provisions for Wind and Seismic (SDPWS)©
©American Wood Council 2020

ASTM F1667-20 Standard Specifications for Driven Fasteners: Nails, Spikes and Staples
© ASTM International April 2017

2021, 2018, 2015, 2012 International Building Code (IBC) © International Code Council Inc. ®

2021, 2018, 2015, 2012 International Residential Code (IRC) © International Code Council Inc. ®

AC116 ICC-ES Acceptance Criteria for Nails
© ICC Evaluation Service (ICC-ES) ® March 2021

AC201 ICC-ES Acceptance Criteria for Staples
© ICC Evaluation Service (ICC-ES) ® December 2020

ICC-ES Evaluation Report ESR-1539®
© ICC Evaluation Service (ICC-ES) ® March 2021

The RV Evans Co.
2325 E Logan Street
Decatur, Illinois 62526
<https://rvevans.wordpress.com/2013/07/15/the-difference-between-screw-shank-nails-and-ring-shank-nails/>

Components of Nail, Smooth Shank Nail, Ring Shank Nail and Screw Shank Nail Sketches courtesy of Senco Brands

Collated Nails Sketches courtesy of PrimeSource Building Products

This technical bulletin is published by ISANTA for education and information only and is not intended as specific professional or technical advice. DO NOT ASSUME that all acceptable procedures are included here or that the information provided is appropriate for every situation.

ISANTA does not “approve” or “endorse” any specific products, services, companies, methods, processes, practices, or sources of information mentioned in the article, and the article should not be referenced in any way which would imply such approval or endorsement.

ISANTA DISCLAIMS ALL GUARANTEES OR WARRANTIES REGARDING THE ACCURACY OR SUFFICIENCY OF THE ARTICLE, AND ISANTA ASSUMES NO RESPONSIBILITY OR LIABILITY IN CONNECTION WITH THE USE, MISUSE, OR OMISSION OF ANY INFORMATION PROVIDED.

